

SETUP SHEET

TRACK CONDITIONS			
Type :	<input type="checkbox"/> Carpet	<input type="checkbox"/> Asphalt	Size: <input type="checkbox"/> Open <input type="checkbox"/> Med. <input type="checkbox"/> Tight
Place :	<input type="checkbox"/> Indoor	<input type="checkbox"/> Outdoor	Traction: <input type="checkbox"/> High <input type="checkbox"/> Med. <input type="checkbox"/> Low
Surface:	<input type="checkbox"/> Smooth	<input type="checkbox"/> Med. <input type="checkbox"/> Bumpy	Track Temp/Air Temp: _____ / _____
Note: _____			

FRONT SUSPENSION	
Track Width: _____ mm	<input type="checkbox"/> Gear Diff _____ wt
Toe Angle: _____	<input type="checkbox"/> Ball Diff
Caster: _____	<input type="checkbox"/> One Way
Camber: _____	<input type="checkbox"/> Spool
Ride Height: _____ mm	Anti-Roll Bar: \emptyset _____ mm
Down Stop: _____ mm	

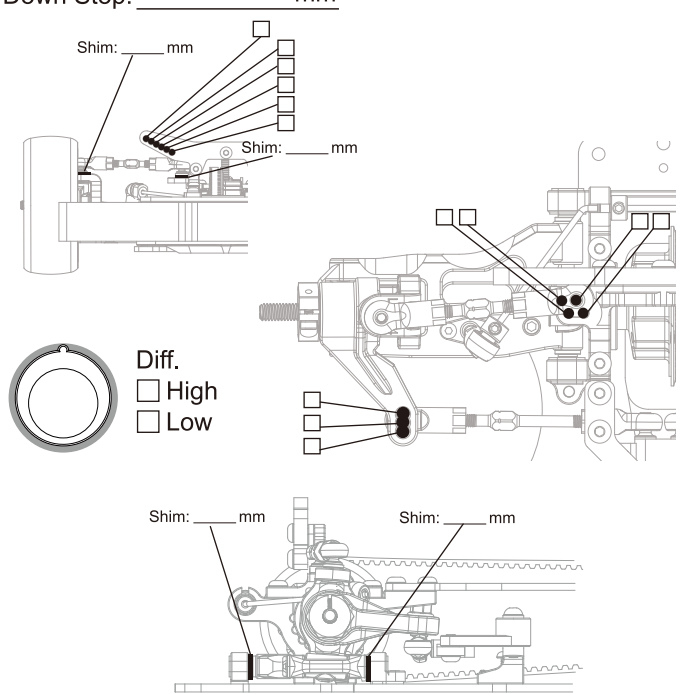

Shim: _____ mm

Shim: _____ mm

Diff. High Low

Shim: _____ mm

Shim: _____ mm

REAR SUSPENSION	
Track Width: _____ mm	<input type="checkbox"/> Gear Diff _____ wt
Toe Angle: _____	<input type="checkbox"/> Ball Diff
Camber: _____	<input type="checkbox"/> Spool
Ride Height: _____ mm	
Down Stop: _____ mm	Anti-Roll Bar: \emptyset _____ mm

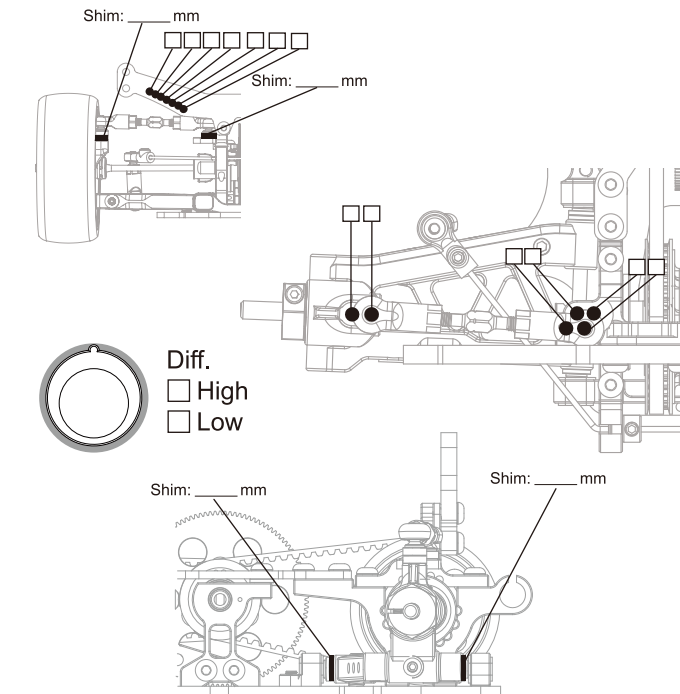







Shim: _____ mm







Shim: _____ mm

Diff. High Low

Shim: _____ mm

Shim: _____ mm

ARM HOLDERS	
(+)  FFL  (-) (-)  FFR  (+)	
	

ARM HOLDERS	
(+)  RFL  (-) (-)  RFR  (+)	
	

ELECTRONICS
Servo: _____
ESC: _____
Battery: _____

DRIVE RATIO
Spur $\frac{T}{T} \times 1.9 =$ _____
Pinion _____

MOTOR
Brand: _____
Turns: _____
Timing: _____

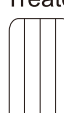
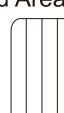
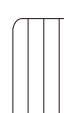
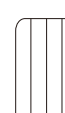
TIRES
Insert: _____
Wheel: _____
Shore/deg: _____
Compound: _____
Tire Temp: _____
Tire additive: _____
Treated Area
   
FL FR RL RR

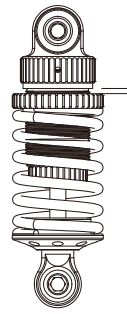
SHOCKS	
	Hole Size: F _____ R _____
	Holes In Piston: F _____ R _____
	Oil wt: F _____ R _____
	Springs: F _____ R _____
	Rebound: F _____ R _____
	Bladder Note: _____
	Thread Length: F _____ R _____

ESC
Punch: _____
Initial Brake: _____
Drag Brake: _____
<input type="checkbox"/> ESC Timing <input type="checkbox"/> Turbo Timing

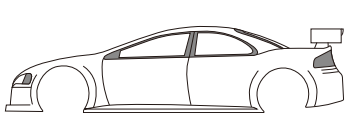
BODY	
	Body: _____
	Wing Height: _____
	Wing Position: _____